



Pre-Rinse Units
B-0113-A08-B08C

TAG:

Easy Install

Pre-Rinse Unit

Architect/Engineering Specifications:

Single hole deck mount mixing faucet with polished chrome plated brass body, add-on faucet with compression cartridge and lever handle, 8" swing nozzle with stream regulator outlet, 24" riser, 44" flexible stainless steel hose, 0.65 GPM low flow spray valve with insulated grip handle, compression cartridges with spring checks, lever handles, 18" flexible stainless steel supply hoses with 1/2" NPSM / 5/8" O.D. compression connections, 6" adjustable wall bracket, spray valve holder and overhead spring. Certified to ASME A112.18.1/CSA B125.1, NSF 61-Section 9 and NSF 372. EPAAct 2005 compliant.

Job Name _____
 Model Specified _____ Quantity _____
 Variations Specified _____
 Date _____

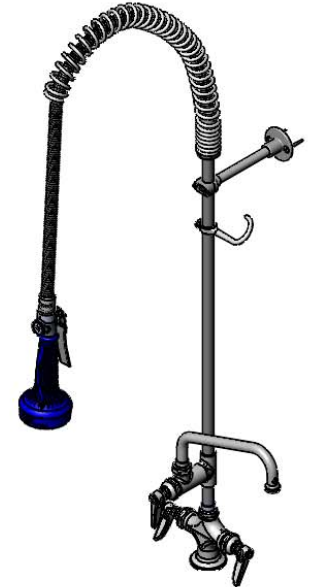
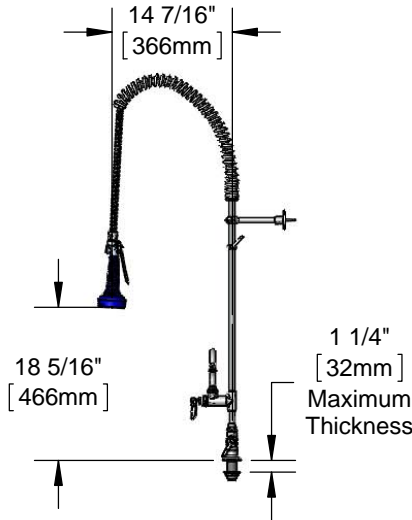
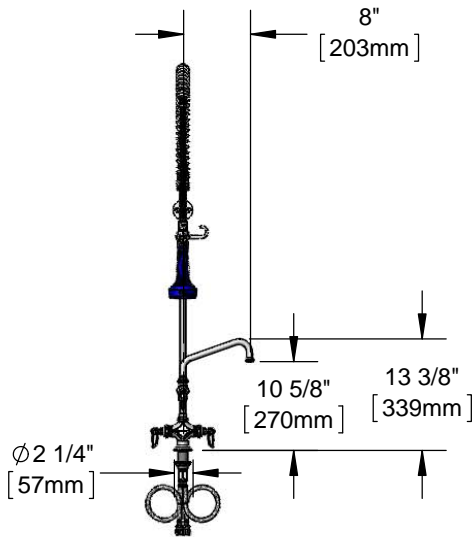

Features & Benefits:

- Single hole deck mount w/ polished chrome plated brass body
- EasyInstall add-on faucet w/ polished chrome plated brass body
- 8" swing nozzle w/ stream regulator outlet, Series 1
- 24" riser
- 44" flexible stainless steel hose
- 0.65 GPM low flow JetSpray spray valve with insulated grip handle, stainless steel trigger and trigger lock
- Eterna compression cartridges w/ internal spring checks to prevent cross flow of water
- Lever handles w/ color coded indexes
- 18" flexible stainless steel supply hoses with 1/2" NPSM / 5/8" O.D. compression connections
- 6" adjustable wall bracket
- Material: Polished chrome plated brass body, add-on faucet, riser and spray valve, stainless steel hose & chrome plated metal handles

Product Compliance:

- ASME A112.18.1 / CSA B125.1
- NSF 61 - Section 9
- NSF 372 (Low Lead Content)
- EPAAct 2005 (PRSV)
- EPA WaterSense (PRSV)



Warranty: Three Year (Limited)

Performance Data:

- Pressure: 20 - 125 psi
- Temperature: 40 °F - 140 °F
- Flow Rate:
 - Spray Valve: 0.65 GPM @ 60 psi
 - Add-On Faucet: 6.49 GPM @ 60 psi

Optional Add-On Faucet Outlets (Series 1 / VR Series 6)

GPM	Aerated	VR Aerated (VR Laminar)
1.0	<input type="checkbox"/> B-0199-01-F10	<input type="checkbox"/> B-0199-06-F10
1.5	<input type="checkbox"/> B-0199-01-WS	<input type="checkbox"/> B-0199-06-WS
2.2	<input type="checkbox"/> B-0199-01	<input type="checkbox"/> B-0199-06

Optional Cartridges With Checks

- Quarter Turn Cerama w/ Check Valve
- Quarter Turn Eterna w/ Spring Check (Standard)

Optional Pre-Rinse Spray Valves

- B-0107 (1.42 GPM)
- B-0107-C (0.65 GPM)
- B-0107-J (1.07 GPM)
- B-0108 (1.48 GPM)
- B-0108-C (0.65 GPM) (Standard)

Optional Handles

- 4" Wrist Action
- Lever (Standard)
- 4-Arm



T&S BRASS AND BRONZE WORKS, INC.



• 2 Saddleback Cove • Travelers Rest, SC 29690
 Ph 800-476-4103 • Fax 864-834-3518
 • Simi Valley, CA • Ph 800-423-0150 • www.tsbrass.com

Date: 08/18/15