



**Architect/Engineering Specifications:**

8" wall mount mixing faucet with polished chrome plated brass body, add-on faucet with compression cartridge and lever handle, 8" swing nozzle with stream regulator outlet, 18" riser, 44" flexible stainless steel hose, 1.48 GPM spray valve with insulated grip handle, compression cartridges with spring checks, lever handles, 1/2" NPT female inlets, spray valve holder and overhead spring. Certified to ASME A112.18.1/CSA B125.1, NSF 61-Section 9 and NSF 372. EPAct 2005 compliant.

Job Name \_\_\_\_\_

Model Specified \_\_\_\_\_ Quantity \_\_\_\_\_

Variations Specified \_\_\_\_\_

Date \_\_\_\_\_

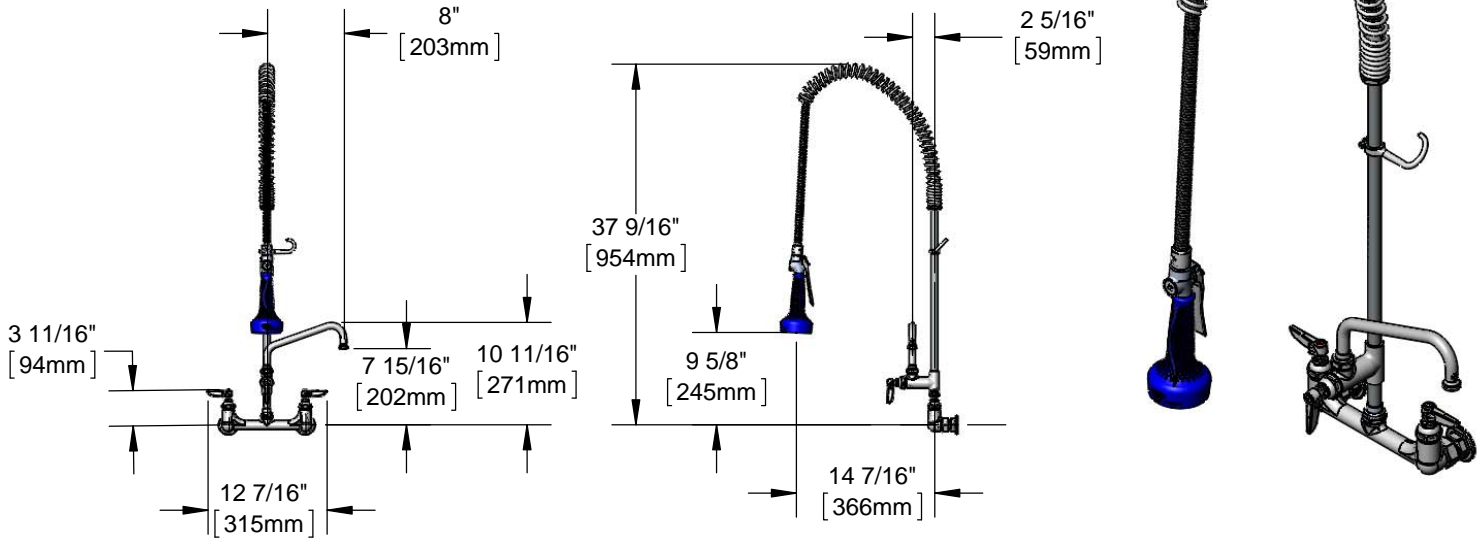

**Features & Benefits:**

- 8" wall mount mixing faucet w/ polished chrome plated brass body
- EasyInstall add-on faucet w/ polished chrome plated brass body
- 8" swing nozzle w/ stream regulator outlet, Series 1
- 18" rigid riser
- 44" flexible stainless steel hose
- 1.48 GPM JeTSpray spray valve with insulated grip handle, stainless steel trigger and trigger lock
- Eterna compression cartridges with internal spring checks to prevent cross flow of water
- Lever handles w/ color coded indexes
- 1/2" NPT female eccentric inlets with Ø 2" flanges
- Adjustable centers from 7 3/4" to 8 1/4"
- Material: Polished chrome plated brass body, tubular nozzle, add-on faucet body, riser & spray valve body, stainless steel hose, and chrome plated metal handles

**Product Compliance:**

- ASME A112.18.1 / CSA B125.1
- NSF 61 - Section 9
- NSF 372 (Low Lead Content)
- EPAct 2005 (PRSV)



**Warranty:** Three Year (Limited)



**Performance Data:**

- Pressure: 20 - 125 psi
- Temperature: 40°F - 140°F
- Flow Rate:
  - Spray Valve: 1.48 GPM @ 60 psi
  - Add-On Faucet: 8.91 GPM @ 60 psi

**Optional Cartridges With Checks**

- Quarter Turn Cerama w/ Check Valve
- Quarter Turn Eterna w/ Spring Check (Standard)

**Optional Handles**

- 4" Wrist Action
- Lever (Standard)
- 4-Arm

**Optional Pre-Rinse Spray Valves**

- B-0107 (1.42 GPM)
- B-0107-C (0.65 GPM)
- B-0107-J (1.07 GPM)
- B-0108 (1.48 GPM) (Standard)
- B-0108-C (0.65 GPM)

**Optional Add-On Faucet Outlets (Series 1 / VR Series 6)**

GPM	Aerated	VR Aerated (VR Laminar)
1.0	<input type="checkbox"/> B-0199-01-F10	<input type="checkbox"/> B-0199-06-F10
1.5	<input type="checkbox"/> B-0199-01-WS	<input type="checkbox"/> B-0199-06-WS
2.2	<input type="checkbox"/> B-0199-01	<input type="checkbox"/> B-0199-06

